

1000 FATIGUE RATED LOAD CELL (U.S. & METRIC)

FEATURES & BENEFITS

- Capacities from 250 to 50K lbf (1.25 to 225 kN)
- Proprietary Interface temperature compensated strain gages
- 100 million fully reversed cycles
- Performance to 0.03%
- Eccentric load compensated
- Low deflection
- 0.0008%/°F (0.0015%/°C) temperature effect on output
- Barometric compensation
- Shunt calibration
- Tension and compression

STANDARD CONFIGURATION



Model 1010ACK-2.5K (shown)

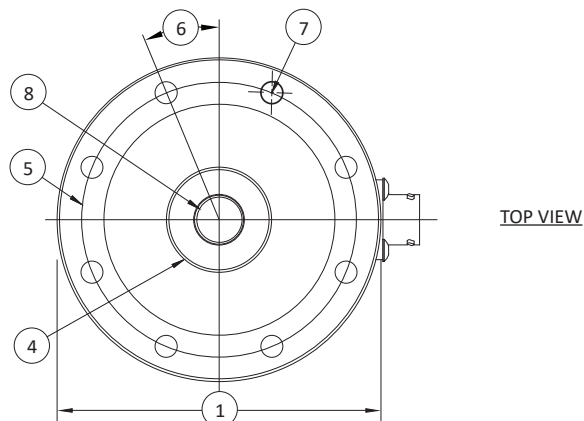
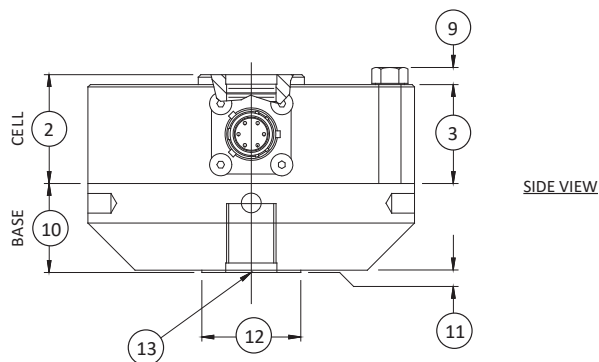

DIMENSIONS

See Drawing	MODEL					
	1010		1020		1032	
	CAPACITY					
	U.S. (lbf)	Metric (kN)	U.S. (lbf)	Metric (kN)	U.S. (lbf)	Metric (kN)
	250, 500, 1K, 2.5K, 5K	1.25, 2.5, 5, 12.5, 25	12.5K, 25K	50, 125	50K	225
	in	mm	in	mm	in	mm
(1)	Ø4.13	Ø104.8	Ø6.06	Ø153.9	Ø8.00	Ø203.2
(2)	1.38	34.9	1.75	44.5	2.50	63.5
(3)	1.25	31.7	1.63	41.4	2.25	57.2
(4)	Ø1.34	Ø34.0	Ø2.65	Ø67.3	Ø3.76	Ø95.2
(5)	Ø3.50	Ø88.9	Ø5.13	Ø130.3	Ø6.50	Ø165.1
(6)	22.5°	22.5°	15.0°	15.0°	11.25°	11.25°
(7)	Ø0.28	Ø7.1	Ø0.41	Ø10.4	Ø0.53	Ø13.5
	8 places		12 places		16 places	
(8)	¾-18 UNF-3B ↓ 1.12	M16x2-4H ↓ 28.4	1 ¼-12 UNF-3B ↓ 1.40	M33x2-4H ↓ 35.6	1 ¼-12 UNF-3B ↓ 2.15	M42x2-4H ↓ 54.6
(9)	0.20	5.1	0.30	7.6	0.40	10.2
(10)	1.13	28.6	1.75	44.5	2.00	50.8
(11)	0.03	0.8	0.03	0.8	0.03	0.8
(12)	Ø1.25	Ø31.8	Ø2.25	Ø57.2	Ø3.00	Ø76.2
(13)	¾-18 UNF-3B ↓ 0.87	M16x2-4H ↓ 22.1	1 ¼-12 UNF-3B ↓ 1.40	M33x2-4H ↓ 35.6	1 ¼-12 UNF-3B ↓ 1.75	M42x2-4H ↓ 44.5

International System of Units (SI) dimensions and capacities are provided for conversion only. Standard products have U.S. capacities and dimensions. SI capacities available upon special request and at an additional cost.

1000 FATIGUE RATED LOAD CELL (U.S. & METRIC)

SPECIFICATIONS

PARAMETERS		MODEL			
		1010	1010	1020	1032
		CAPACITY			
Measuring Range	U.S. (lbf)	250, 500, 1K	2.5K, 5K	12.5K, 25K	50K
	Metric (kN)	1.25, 2.5, 5	12.5, 25	50, 125	225
ACCURACY - (MAX ERROR)					
Static Error Band – %FS		±0.03	±0.04	±0.04	±0.05
Nonlinearity – %FS		±0.04	±0.04	±0.04	±0.05
Hysteresis – %FS		±0.03	±0.04	±0.05	±0.05
Nonrepeatability – %RO		±0.02	±0.02	±0.02	±0.02
Creep, in 20 min – %		±0.025	±0.025	±0.025	±0.025
Side Load Sensitivity – %		±0.1	±0.1	±0.1	±0.1
Eccentric Load Sensitivity – % / in		±0.1	±0.1	±0.1	±0.1
TEMPERATURE					
Compensated Range	°F	+15 to +115	+15 to +115	+15 to +115	+15 to +115
	°C	-10 to +45	-10 to +45	-10 to +45	-10 to +45
Operating Range	°F	-65 to +200	-65 to +200	-65 to +200	-65 to +200
	°C	-55 to +90	-55 to +90	-55 to +90	-55 to +90
Effect on Zero – %RO / deg	°F	±0.0008	±0.0008	±0.0008	±0.0008
	°C	±0.0015	±0.0015	±0.0015	±0.0015
Effect on Output – % / deg	°F	±0.0008	±0.0008	±0.0008	±0.0008
	°C	±0.0015	±0.0015	±0.0015	±0.0015
ELECTRICAL					
Rated Output – mV/V (Nominal)		1.0	2.0	2.0	2.0
Excitation Voltage – VDC MAX		20	20	20	20
Bridge Resistance – Ohm (Nominal)		350	350	350	350
Zero Balance – %RO		±1.0	±1.0	±1.0	±1.0
Insulation Resistance – Megohm		5000	5000	5000	5000
MECHANICAL					
Safe Overload – %CAP		±300	±300	±300	±300
Deflection @ RO	in	0.0005	0.001	0.001	0.002
	mm	0.013	0.025	0.025	0.050
Optional Base – P/N (Metric)		B101 (M)	B102 (M)	B103 (M)	B112 (M)
Natural Frequency – kHz		5.0, 6.9, 9.8	6.6, 9.4	6.5, 7.0	5.8
Weight	lbs	1.5	3.3	9.5	26
	kg	0.7	1.5	4.3	12
Calibration		Tension & Compression			
Material		Aluminum		Alloy Steel	

OPTIONS

- Base (recommended)
- Connector protection
- Standardized output
- Transducer Electronic Data Sheet (TEDS)
- Custom calibration
- Multiple bridge
- Special threads
- Dual diaphragm
- Special temperature range
- Cable length
- Add connector to cable

CONNECTOR OPTIONS

- Integral cable – 10 ft (3 m)
- PT02E-10-6P bayonet connector
- PC04E-10-6P screw-type connector

ACCESSORIES

- Mating connector
- Mating cable
- Instrumentation
- Loading hardware

1000 FATIGUE RATED LOAD CELL (U.S. & METRIC)

BAYONET CONNECTOR



Model 1010ACK-2.5K-B (Shown)

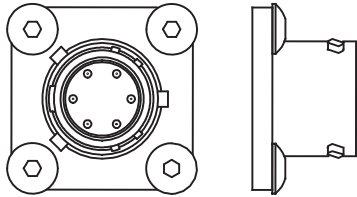

SCREW TYPE CONNECTOR



Model 1010AF-2.5K-B (Shown)

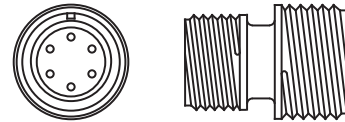

INTEGRAL 10 FT. CABLE CONNECTOR



Model 1010AJ-2.5K-B (Shown)

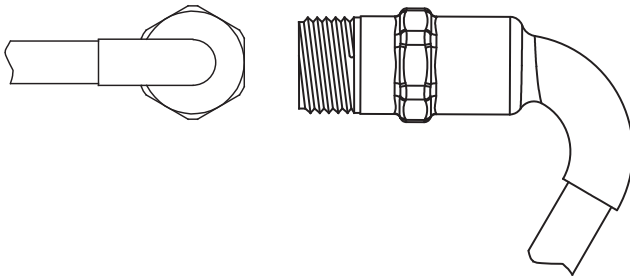

BASE

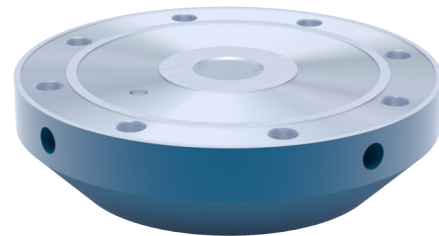

Model B1XX-1 (Shown)