

FEATURES

- Cermet resistive element
- Dust proof enclosure
- Plastic material according to UL94V-0
- Alumina substrate
- Also upon request:
 - Wiper positioned at 50% or fully clockwise.
 - Long life model for low cost control pot. applications
 - Supplied in magazines for automatic insertion.
 - Low torque option
 - Available as SPDT switch
 - Laser trimming for tighter tolerances
 - Special tapers
 - Mechanical detents

MECHANICAL SPECIFICATIONS

- Mechanical rotation angle: $265^\circ \pm 5^\circ$
- Electrical rotation angle: $240^\circ \pm 20^\circ$
- Torque: 0.5 to 2.5 Ncm. (0.7 to 3.4 in-oz)
- Stop torque: > 10 Ncm. (>14 in-oz)

ELECTRICAL SPECIFICATIONS

- Range of values (*)
 $100\Omega \leq R_n \leq 5\text{ M}$ (Decad. 1.0 - 2.0 - 2.2 - 2.5 - 4.7 - 5.0)
 - Tolerance (*): $100\Omega \leq R_n \leq 1\text{M}\Omega$ $\pm 20\%$
 $1\text{M}\Omega < R_n \leq 5\text{M}\Omega$ $\pm 30\%$
 - Max. Voltage: 250 VDC (lin) 125 VDC (no lin)
 - Nominal Power 70°C (158°F) (see power rating curve)
0.50 W (lin) 0.25 W (no lin)
 - Taper (*) (Log. & Alog. only $R_n \geq 1\text{K}$) Lin ; Log; Alog.
 - Residual resistance(*): $\leq 0.5\%$ R_n (5 Ω min.)
 - Equivalent Noise Resistance: $\leq 3\%$ R_n (3 Ω min.)
 - Operating temperature: $-40^\circ\text{C} + 90^\circ\text{C}$ ($-40^\circ\text{F} + 194^\circ\text{F}$)
- (*) Others upon request

HOW TO ORDER

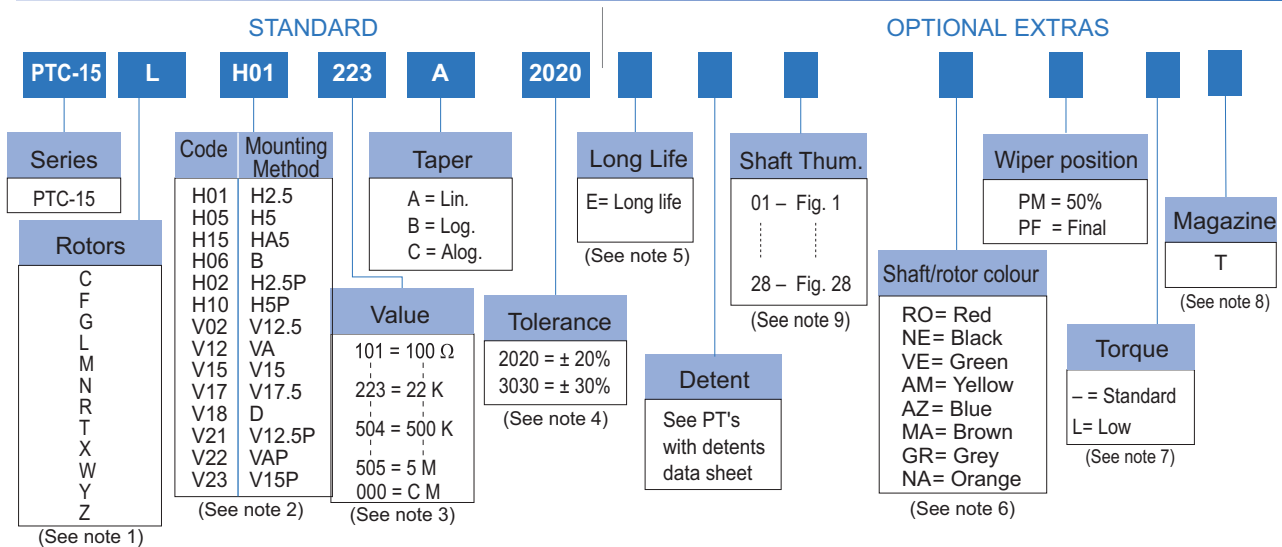

NOTES:

- "Z" adjustment only available on "H" versions. Standard colour for the "T" rotor: Orange
- Terminals styles: "P" are crimped terminals. V=Vertical adjust; H=Horizontal Adjust
- Value Example: Code: 10 1 100 Ω
 ↳ Num of zeros
 ↳ First two digits of the value. 000 = CM: SPDT switch 45°
- Non standard tolerance, upon request. Example: +7% Code: 07 05
 ↳ negative tolerance
 ↳ positive tolerance
- Life
 - Standard 100 cycles
 - Long life 10000 cycles
- Colour shaft/rotor:
 - Potentiometer without shaft: only rotor
 - Potentiometer with shaft: only shaft
- Low Torque: $\leq 1.5\text{Ncm}$. No detent option available for low torque models
- Magazines (35 pcs/mag): available for VA (12.5), V (12.5), V (12.5P), V (15), V15 (P) and H models. For more information please contact your nearest Piher supplier.
- If you wish to use your own custom plastic shaft/knob/actuator please contact Piher for advice about compatible materials.

NOTE: The information contained here should be used for reference purposes only.

HOW TO ORDER CUSTOM DRAWING

PTC-15 LH 01 + DRAWING NUMBER (Max. 16 digits)

This way of ordering should be used for options which are not included in the "How to order" standard and optional extras.

STANDARD OPTIONS

Detents	None
Rotor colour	Natural
Shaft colour	Natural
Wiper position	Initial
Torque	Standard

ROTORS

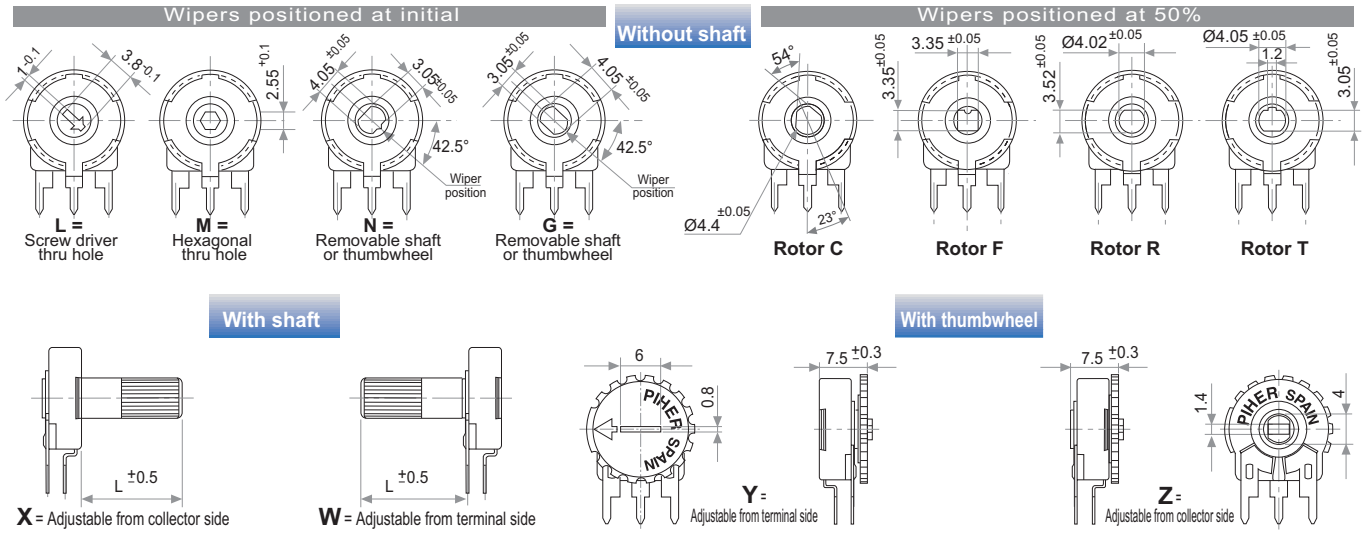

VERTICAL MOUNTING – HORIZONTAL ADJUSTMENT

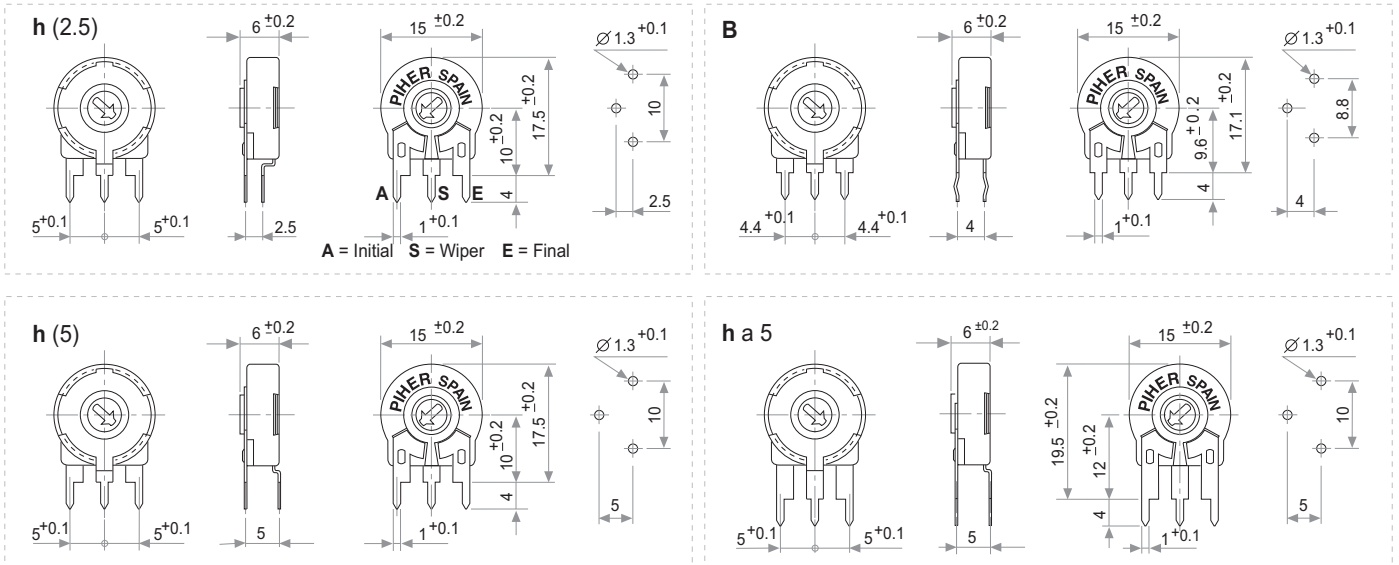

HORIZONTAL MOUNTING – VERTICAL ADJUSTMENT

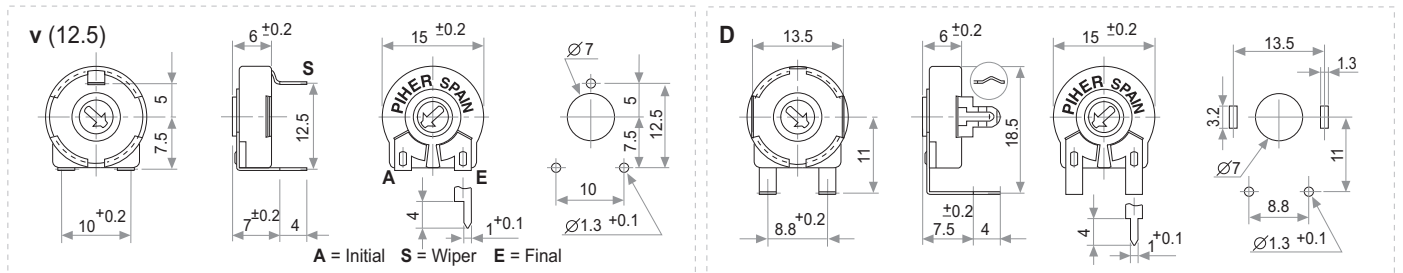

HORIZONTAL MOUNTING – VERTICAL ADJUSTMENT

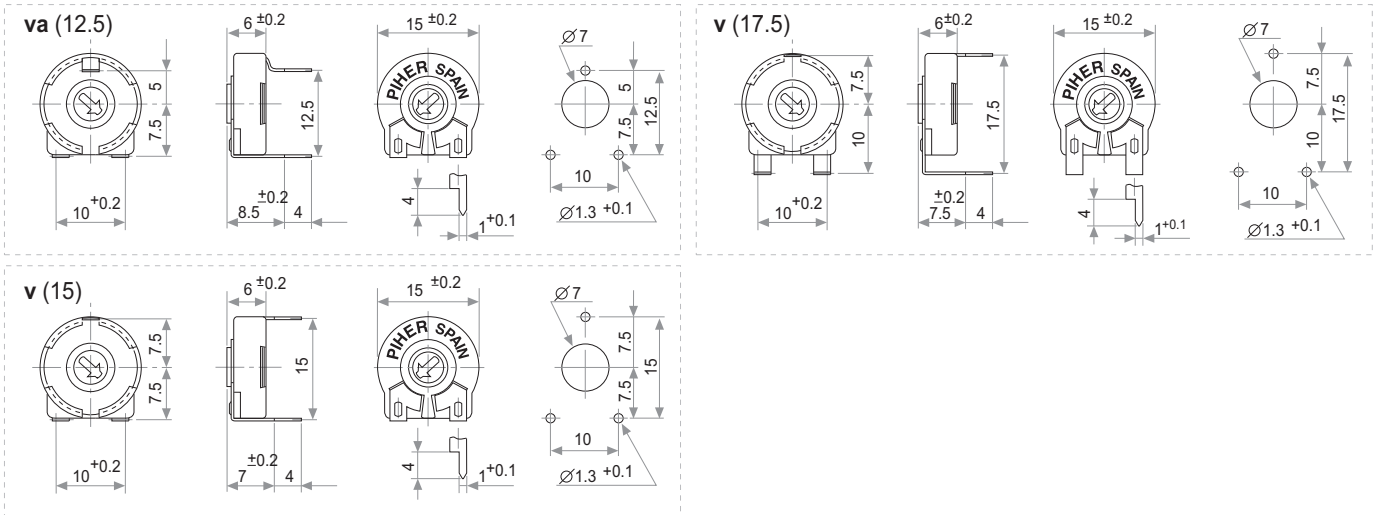

CRIMPED TERMINALS (DETAIL)

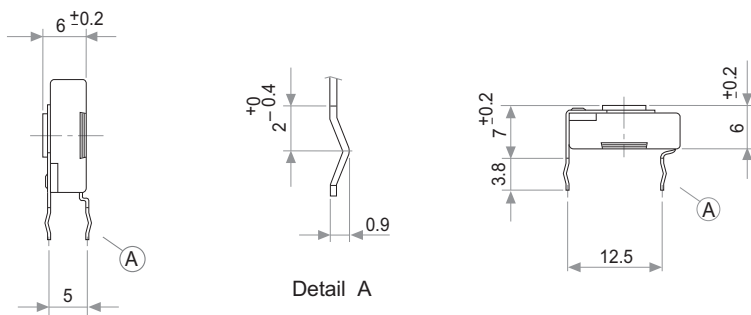

POWER RATING CURVE

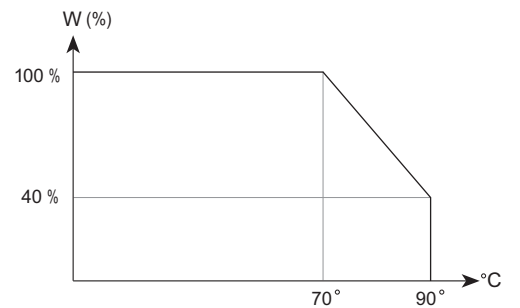

TAPER

NOTE = Please note relative terminal positions when ordering non linear tapers.

A = Linear
B = Log.
C = Alog.

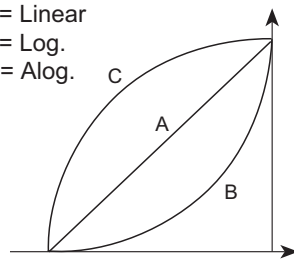

Standard

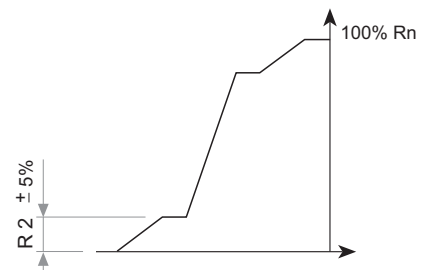

Special curve example

OPTIONS

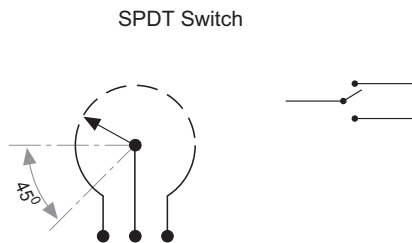

SPDT Switch

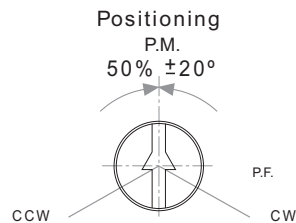

Std. Position = CCW

TESTS

TYPICAL VARIATIONS

ELECTRICAL LIFE	1.000 h. @ 70°C; 0.5 W	± 5 %
MECHANICAL LIFE (CYCLES)	100 @ 10 CPM ...15 CPM	± 3 % (Rn < 1 MΩ)
TEMPERATURE COEFFICIENT	-40° C; +90° C	± 100 ppm (Rn <100 K)
THERMAL CYCLING	16 h. @ 90° C; 2h. @ -40° C	± 2.5 %
DAMP HEAT	500 h. @ 40° C @ 95% HR	± 5 %
VIBRATION (for each plane X,Y,Z)	2 h. @ 10 Hz. ... 55 Hz.	± 2 %

NOTE: Out of range values may not comply these results.

SHAFTS

Hollow model shafts

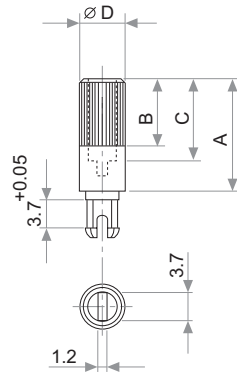

A = Length (FRS)
 B = Knurling length
 C = Hollow depth
 D = Shaft diameter
 FRS = From rotor surface

FIG.	A	B	C	D	Ref.
1	12	9	8	6	5272
2	19	9	15	6	5214
5	9.5	6.5	5.5	6	5208
9	35	9	31	6	5216
10	37.8	9	33.8	6	5218
11	35	25	15	6	5209
13	7.8	4.8	3.8	6	5265

Solid model shafts

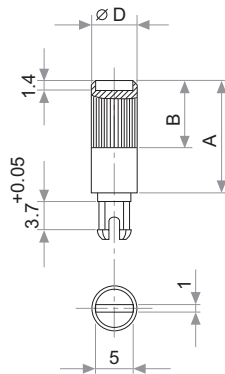
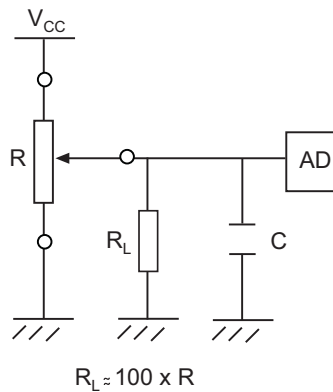

FIG.	A	B	D	Ref.
6	15	9	6	5219
7	16.8	9	6	5220
8	25.3	9	6	5207
12	46	5	6	5227

Slott (1 x 1.4) perpendicular to wiper position. Fig. 12 slot is on line with wiper position.

RECOMMENDED CONNECTIONS

Recommended connection scheme for Piher's position sensors (voltage divider)



SHAFTS

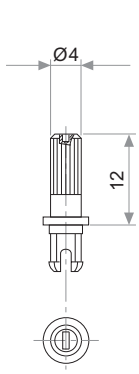

Fig. 3 / Ref. 5372

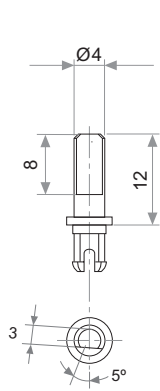

Fig. 15 / Ref. 5217

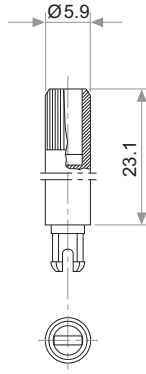

Fig. 17 / Ref. 5210

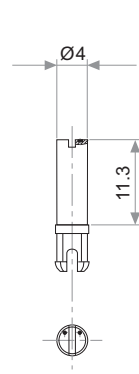

Fig. 18 / Ref. 5271

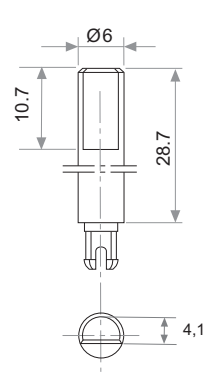

Fig. 19 / Ref. 6032*

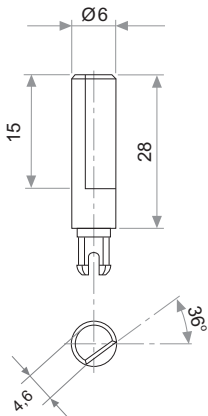

Fig. 20 / Ref. 5369*

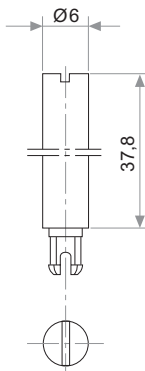

Fig. 21 / Ref. 6031*

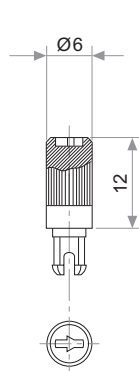

Fig. 22 / Ref. 6029

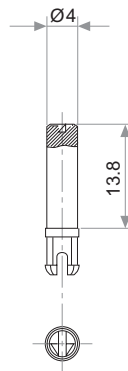

Fig. 23 / Ref. 6022

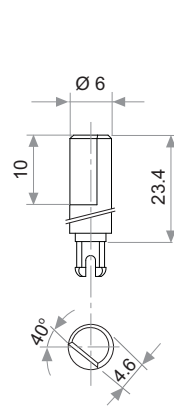

Fig. 29 / Ref. 6162

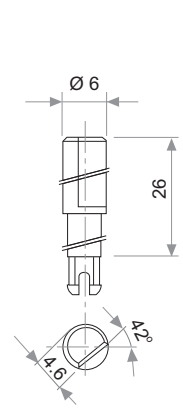

Fig. 25 / Ref. 6059

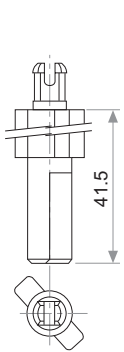

Fig. 27 / Ref. 5268*

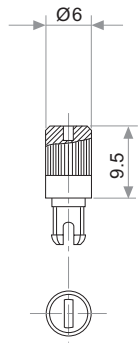

Fig. 28 / Ref. 6055

* Not available in self extinguishable plastic

THUMBWHEEL

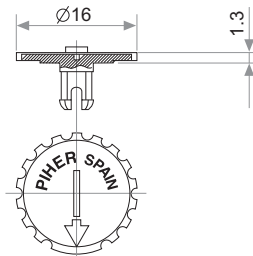

Fig. 4 / Ref. 5371