

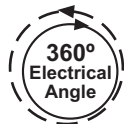

✓ Fully Customisable



✓ Reflow Soldering

FEATURES

Electrical angle: 360°

Designed for direct input to microprocessor.

SMD, Horizontal or Through-hole Mount

Endless Rotation

Extended Mechanical Life

Working Temperature Range (-40°C to +120°C)

Low Profile (4.4 mm)

Linearity (independent): ±2%

Embossed Tape or Bulk packaging

Reflow Soldering capability

Plug-in shafts

Shaft insertable from both sides

Polarised "T" rotor (European Home Appliance standard)

Ideal for Consumer Control and position sensing applications

STANDARD SPECIFICATIONS

Resistance values*:	3.3k
Tolerance:	± 40%
Nominal Power:	0.15 W @ 50°C
Linearity (independent):	± 2%
Mechanical Life**:	100,000 cycles
Temperature Range:	-40°C to +120°C
Mechanical Angle:	360°
Rotational Torque:	≤ 20 mN.m
Max. Voltage:	22 VDC

(* Others upon request

(**) 200,000 cycles version available upon request

APPLICATIONS

This device is aimed to applications that need on-field arbitrary initial and final travel reference points calibration.

Once these have been set, the A15-3P provides accurate position feedback output to the controller.

Designed to be a cost-effective replacement for absolute encoders, the A15-3P series offers an SMD, Vertical and Through Hole mount solution for the majority of **Position/Angle Rotary Sensor** and **multi-purpose Control applications** such as garage door openers, gauges, rotary actuators and robotics.

SCHEMATIC AND FUNCTIONALITY

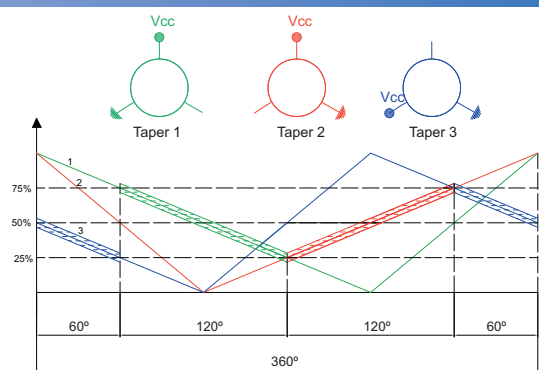
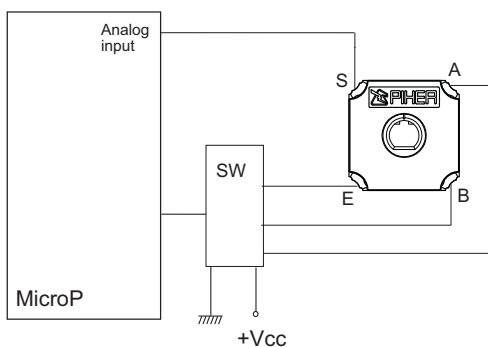

HOW TO ORDER

A15-3P	T	S	332	4040
Series	Rotors	Mounting Method	Value	Tolerance
A15-3P	T	V = Through Hole S = SMD	332 = 3.3 K Others upon request	4040 = ± 40%

NOTES:

Shafts are not available mounted to the potentiometer and should be ordered separately

ISO TS 16949 / ISO 14001

NOTE: The information contained here should be used for reference purposes only.

TESTS

TYPICAL VARIATIONS

ELECTRICAL LIFE	1.000 h. @ 50°C; 0.15 W	±40 %
MECHANICAL LIFE (CYCLES)	100,000 @ 20 CPM	±40 % (Rn < 100 K)
TEMPERATURE COEFFICIENT	-40°C to +120°C	±300 ppm (Rn < 100 K)
THERMAL CYCLING	10h. @ 120°C; 10h. @ -40°C	±40 %
DAMP HEAT	500 h. @ 40°C @ 95% HR	±40 %

NOTE : Out of range values may not comply these results.

PACKAGING

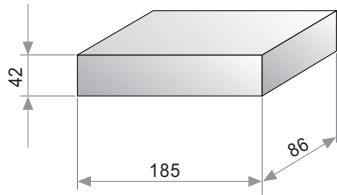

BULK

150 Units per box.
Through hole version only

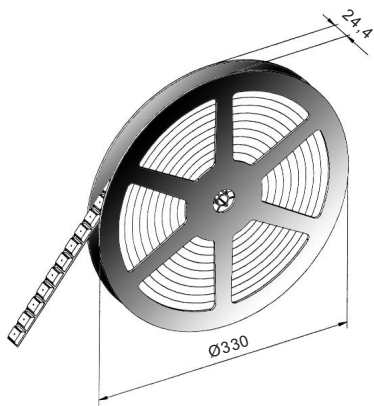

EMBOSSED TAPE

500 Units per Reel
SMD version only

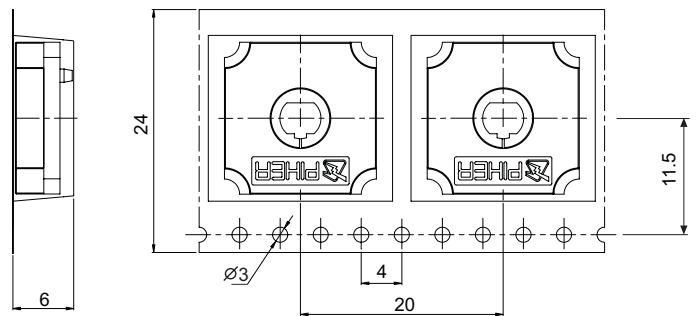

RECOMMENDED REFLOW PROFILE (SMD types)

SnPb Reflow Profile

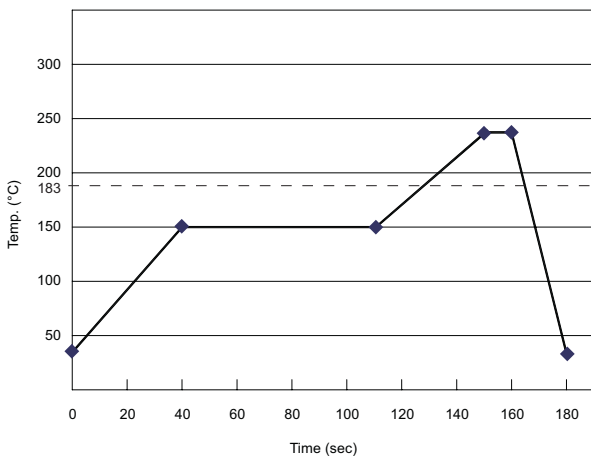

Lead Free Reflow Profile

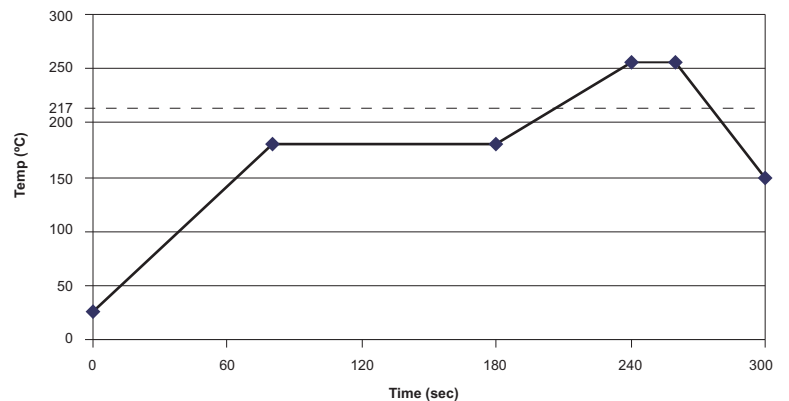

SHAFTS

Hollow model shafts

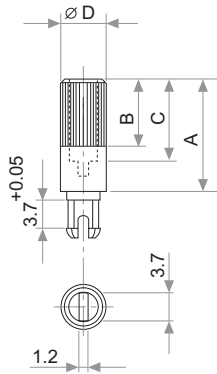

FIG.	A	B	C	D	Ref.
1	12	9	8	6	5272
2	19	9	15	6	5214
5	9.5	6.5	5.5	6	5208
9	35	9	15	6	5216
10	37.8	9	33.8	6	5218
11	35	25	15	6	5209
13	7.8	4.8	3.8	6	5265

Solid model shafts

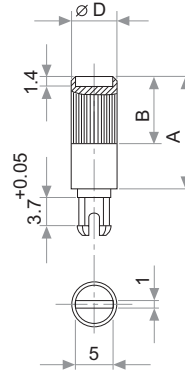

FIG.	A	B	D	Ref.
6	15	9	6	5219
7	16.8	9	6	5220
8	25.3	9	6	5207
12	46	5	6	5227

Slot (1 x 1.4) perpendicular to wiper position. Fig. 12 slot is on line with wiper position.

A = Length (FRS); B=Knurling length; C=Hollow depth; D=Shaft diameter; FRS=From rotor surface

Other shafts

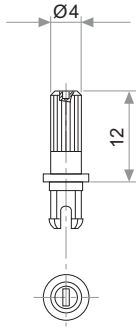

Fig. 3 / Ref. 5372

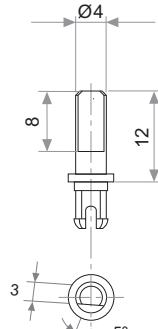

Fig. 15 / Ref. 5217

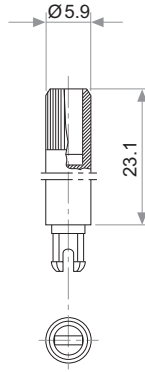

Fig. 17 / Ref. 5210

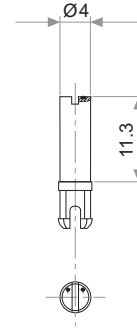

Fig. 18 / Ref. 5271

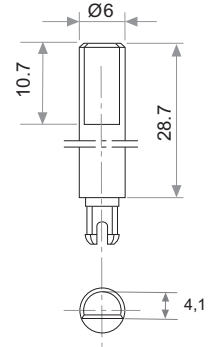

Fig. 19 / Ref. 6032*

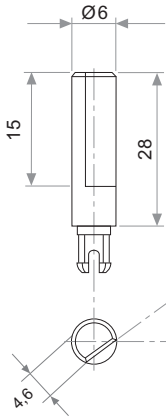

Fig. 20 / Ref. 5369*

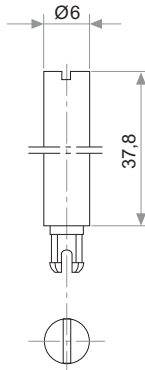

Fig. 21 / Ref. 6031*

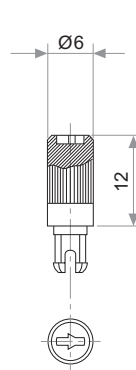

Fig. 22 / Ref. 6029

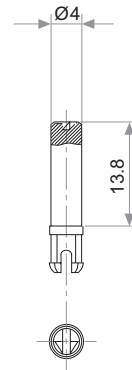

Fig. 23 / Ref. 6022

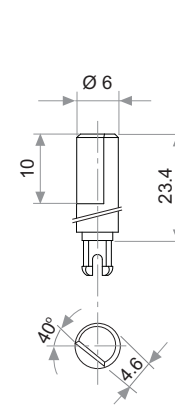

Fig. 29 / Ref. 6162

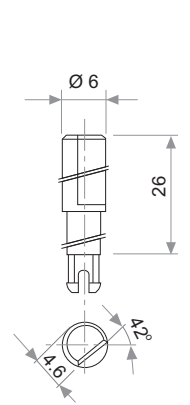

Fig. 25 / Ref. 6059

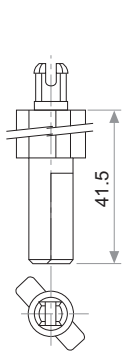

Fig. 27 / Ref. 5268*

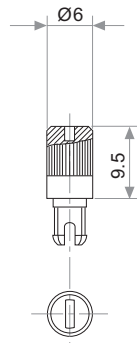

Fig. 28 / Ref. 6055

* Not available in self extinguishable plastic

POWER RATING CURVE

