

PROPRIETARY AND CONFIDENTIAL

THE INFORMATION CONTAINED IN THIS DRAWING IS THE SOLE PROPERTY OF DYTRAN INSTRUMENTS INC. ANY REPRODUCTION IN PART OR AS A WHOLE WITHOUT THE WRITTEN PERMISSION OF DYTRAN INSTRUMENTS, INC. IS PROHIBITED

REVISIONS

REV.	ECN	DESCRIPTION	BY/DATE	CHK	APPR
C	5683	SEE ECN	EP 01/15/09	JS	DU

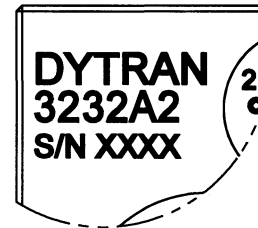
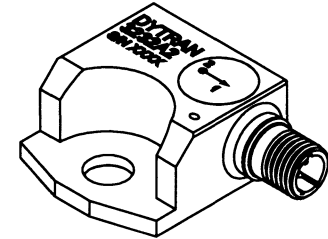
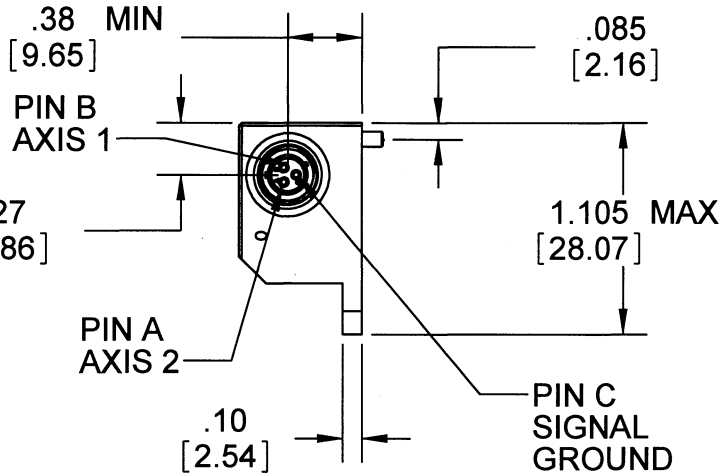
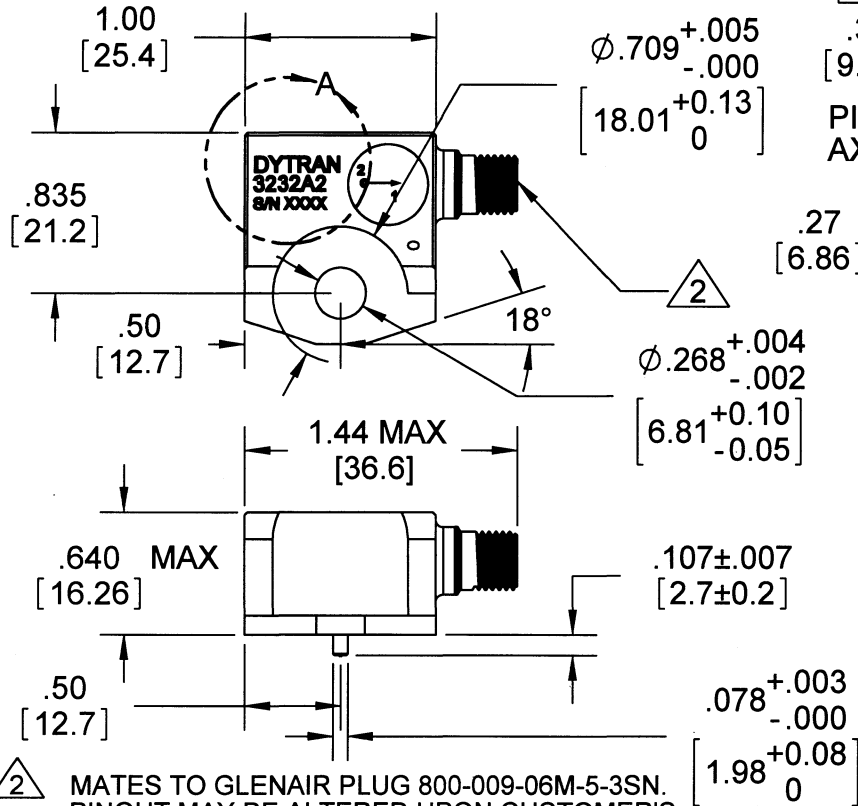

**DETAIL A
SCALE 2 : 1**

2 MATES TO GLENAIR PLUG 800-009-06M-5-3SN. PINOUT MAY BE ALTERED UPON CUSTOMER'S REQUEST.

1. THE DIRECTIONS OF TWO SENSITIVE AXIS MAY BE ALTERED UPON CUSTOMER'S REQUEST.

NOTES: UNLESS OTHERWISE SPECIFIED

3232A2	USED ON	NEXT ASSY
APPLICATION		
THIRD ANGLE PROJECTION USA		

UNLESS OTHERWISE SPECIFIED:
 INTERPRET DIM & TOL PER ASME Y14.5M - 1994.
 REMOVE BURRS.
 COUNTERSINK INTERNAL THDS 90° TO MAJOR DIA.
 CHAM EXT THDS 45° TO MINOR DIA.
 THD LENGTHS AND DEPTHS ARE FOR MIN FULL THDS.
 THDS PER MIL-S-7742.
 DIMENSIONS APPLY AFTER FINISHING.
 ALL MACHINED SURFACES.
 TOTAL RUNOUT WITHIN .005.
 BREAK SHARP EDGES .005 TO .010.
 MACHINED FILLET RADII .005 TO .015.
 WELDING SYMBOLS PER AWS A2.4.
 ABBREVIATIONS PER MIL-STD-12.

UNLESS OTHERWISE SPECIFIED:
 DIMENSIONS ARE IN INCHES. DIMENSIONS IN BRACKETS [] ARE IN MILLIMETERS
 TOLERANCES ARE:
 INCHES METRIC ANGLES
 .XX ± .03 .X ± 0.8 ± 1°
 .XXX ± .010 .XX ± 0.25

MATERIAL

FINISH

DO NOT SCALE DRAWING

CONTRACT NO.	
APPROVALS	DATE
ORIG DV	02/15/08
CHK CES	06/02/08
APP DV	06/02/08
APP	

DYTRAN INSTRUMENTS, INC. MASTER ONLY IF IN RED
 OAKLAND, CA

TITLE: **OUTLINE/INSTALLATION, MODEL 3232A2**

SIZE A	CAGE CODE 2W033	DWG. NO. 127-3232A2	REV C
SCALE: 1:1	SOLIDWORKS	SHEET 1 OF 1	

MODEL NUMBER 3232A2	PERFORMANCE SPECIFICATION	DOC NO. PS3232A2
	BIAXIAL ACCELEROMETER, IEPE	REV B, ECN 8340,02/20/12

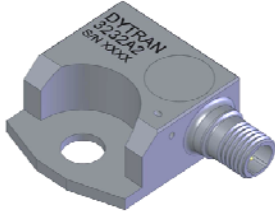

- **BIAXIAL ACCELEROMETER**
- **INTERNALLY CASE ISOLATED**

PHYSICAL

Weight
Mounting Provision, integral bracket
Connector (Mighty Mouse), side exit
Material Body

	ENGLISH		SI	
Weight	1.575	oz	45.0	grams
Mounting Provision	Ø.27 thru hole		Ø.27 thru hole	
Connector (Mighty Mouse)	3 PIN	Type	3 PIN	
Material Body	304L CRES	Material	304L CRES	

PERFORMANCE

Sensitivity +/- 10% [1]	100	mV/g	10.2	mV/ m/s ²
Range F.S. For ± 5 Volts Output	± 50	g pk	± 490.5	m/s ² pk
Frequency Range, ± 10%	3.3 to 2500	Hz	3.3 to 2500	Hz
Resonant Frequency	>30	kHz	>30	kHz
Equivalent Electrical Noise Floor	0.0005	g rms	0.005	m/s ² rms
Linearity [2]	± 1%	%F.S	± 1%	%F.S
Transverse Sensitivity, Max.	5%		5%	
Strain Sensitivity @250µε	0.012	g/µε	0.012	g/µε
	+/-1	Hz	+/-1	%F.S

ENVIROMENTAL

Maximum Vibration	500	±gpk	4900	± m/s ² pk
Maximum Shock	5000	±gpk	49000	± m/s ² pk
Temperature Range	-60 to +250	°F	-51 to 121	°C
Seal	Hermetic		Hermetic	
Coefficient Of Thermal Sensitivity	0.002	%/°F	0.002	%/°C

ELECTRICAL

Supply Current [3]	2 to 20	mA	2 to 20	mA
Compliance Voltage Range	18 to +30	V	18 to +30	V
Output Impedance TYP	100	ω	100	ω
Bias Voltage	10 to 11.5	VDC	10 to 11.5	VDC
Discharge Time Constant	0.1-0.5	sec	0.1-0.5	sec
Output Signal Polarity [4]	positive		positive	
Electrical Isolation [5]	10	GΩ	10	GΩ

This family also includes:

Model	Sensitivity (mV/g)	Range (Gpeak)	Resolution (Grms)	Oper. Temp(°F)	TC

Refer to the performance specifications of the products in this family for detailed description.

Notes:

- [1] Measured at 100 Hz, 1 grams per ISA RP 37.2.
- [2] Measured using zero-based best straight-line method, % of F.S. or any lesser range.
- [3] Do not apply power to this device without current limiting, 20 mA MAX. To do so will destroy the integral IC amplifier.
- [4] For acceleration axial with cable axis.
- [5] Electrical ground isolated from sensor case.
- [6] In the interest of constant product improvement, we reserve the right to change specifications without notice.

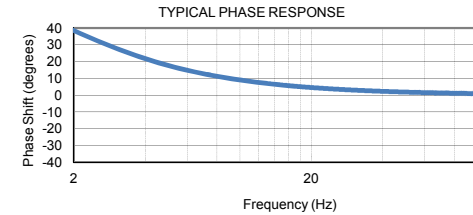
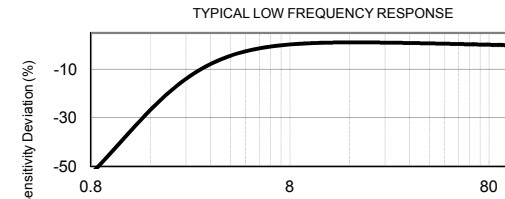
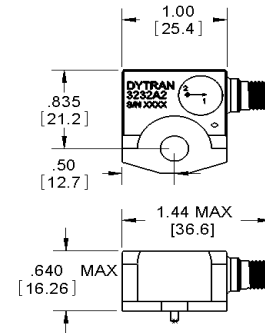

Units on the line drawing are in inches, units in brackets are in millimeters. Refer to 127-3232A2 for more information.



21592 Marilla Street, Chatsworth, California 91311 Phone: 818.700.7818 Fax:818.700.7880
www.dytran.com For permission to reprint this content, please contact info@dytran.com